

Seismic Behavior of a Secondary System on a Yielding Torsionally Coupled Primary System

Abhijit K. Agrawal¹ and T.K. Datta²

1. Research Scholar, Department of Civil Engineering, IIT Hauz Khas, New Delhi, India 110-016
2. Professor, Department of Civil Engineering, IIT Hauz Khas, New Delhi, India 110-016

ABSTRACT: *Dynamic analysis of a secondary system mounted on a torsionally coupled non-linear primary system is presented for bi-directional random earthquake excitation, which is idealized as a broad band stationary random process. The hysteretic force deformation behavior of the non-linear primary system is modelled by a set of coupled non-linear differential equations. The responses are obtained by the linearized frequency domain spectral analysis and are compared with those obtained by the time domain simulation procedure. The response quantities of interest are the relative displacement between the primary and the secondary structural systems and the absolute acceleration of the secondary system itself. The response behavior of the secondary system is examined under a set of parametric variations. These parameters include the uncoupled lateral frequencies of the primary and the secondary structural systems; the ratio of the uncoupled lateral to rotational frequencies of the primary system; the hysteretic parameters of the primary system; eccentricity ratios of the primary and the secondary structural systems in x and y directions; damping ratios of the primary and the secondary structural systems; and the mass ratio of the two sub-systems. Some of the results of the study show that the responses of the secondary system increase with the increase in normalized eccentricities of the primary system under the tuned condition. However, an opposite trend is observed under the untuned condition. Responses of the secondary system is found to be more if the interaction between the primary and the secondary structural systems is considered. Further, responses of the secondary system decrease with the increase in the mass ratio between the secondary and the primary systems.*

Keywords: Primary and secondary systems; Non-classical damping; Torsionally coupled system; Linearized frequency domain; Spectral analysis; Primary-secondary interaction; Bi-directional excitation

1. INTRODUCTION

Seismic response analysis of the light secondary system (S-system), mounted on a primary system (P-system), is important in relation to the performance of delicate equipments and suspension systems in buildings, nuclear power plants, lifeline systems, etc. The seismic design of such structural systems has attracted considerable attention in recent years [Kiureghian et al [11]; Lin and Mahin [12]; Chen and Lutes [5]; Suarez and Singh [16]; Jangid and Datta [10]; Huang and Soong [8]]. Analysis of the primary-secondary system (PS-system), using elastic theory, is suitable for wind and mild earthquakes. Under severe earthquakes, the P-system generally undergoes nonlinear excursion and also shows torsional behavior. In such situations, an elastic model of the P-system gives inaccurate design of the PS-system. Thus, the response analysis of the S-system, attached to a yielding P-system,

is of practical interest.

Lin and Mahin [12] found that responses (relative displacement between the primary and the secondary structural systems and the absolute acceleration of the secondary structural system itself) of the S-system decrease due to yielding of the P-system, when its natural frequency equals to or is greater than that of the elastic structure. Under some parametric conditions, increase in responses of the S-system, due to yielding of the P-system, were identified by Chen and Soong [4]. For multi-degree-of-freedom (MDOF) yielding primary-secondary structural systems, Sewel et al [15] found that the responses of the S-system increase due to yielding of the P-system, and they are substantial under some parametric conditions.

Chen and Lutes [5] studied the non-linear behavior of a SDOF linear S-system due to yielding of the primary

structural system under random ground excitation. They observed that under some parametric conditions, non-linearity in the P-system significantly affects the first passage failure and reliability of the secondary structural system. Huang and Soong [8] found that under some specific conditions, yielding of the P-system alleviates sensitivity of the S-system and its responses are amplified due to shifting of the primary structural frequencies. Using the time history integration technique, Igusa [9] found that yielding of the P-system may result in responses, which are small fractions of the corresponding linear responses.

All the above studies on the S-system, mounted over the inelastic P-system, are carried out for symmetric buildings or buildings with very small eccentricities or buildings torsionally very stiff. Since most of the practical buildings are unsymmetric 3-D buildings, the seismic behavior of the secondary system mounted on torsionally coupled primary system is of practical importance [18, 19]. Furthermore, since the earthquake is a multi-directional process, the seismic behavior of the S-system under bi-directional seismic excitation should be investigated for the yielding P-system by considering the effect of the bi-directional interaction on the yielding. There is a lack of investigations in the above areas.

Recently, Agrawal and Datta [1] studied the behavior of a S-system mounted over a torsionally coupled non-linear P-system, to uni-directional ground excitation, for a 2-D model (i.e. one way eccentric P-system). They also studied behavior of the S-system mounted over torsionally coupled and linear P-system for this condition. In this paper, the response behavior of a secondary

structural system mounted on a torsionally coupled non-linear primary structural system is investigated for bi-directional random ground excitation, modelled as a white noise. Objectives of the study are: (i) to investigate the effect of yielding of the P-system on the responses of the S-system; (ii) to study the effect of linearization on the response behavior of the S-system; and (iii) to investigate the effect of the interaction between the primary and the secondary structural systems on the responses of the S-system. The above studies are made under different important parametric variations.

2. SYSTEM MODEL

Figure 1 shows the structural system considered, which is an idealized single story building model, over which a cantilever type S-system is mounted. It is assumed that the cantilever rod is axially inextensible and has the same flexural stiffness corresponding to the displacement in any direction, in the horizontal plane. Similarly, damping of the S-system is assumed to be constant in all directions. The S-system is excited and oscillated in the direction which depends on the motion of the P-system. The normalized eccentricities of the P-system are varied to provide various degrees of torsional coupling in the P-system. The square columns of the P-system exhibit hysteretic behavior under random ground excitations.

Let $K_{pi}(i=1,4)$ represent the initial lateral stiffness of the i^{th} resisting element, then the total initial stiffness of the P-system, same in both x and y directions, is given by

$$K_p = \sum_{i=1}^4 K_{pi} \tag{1}$$

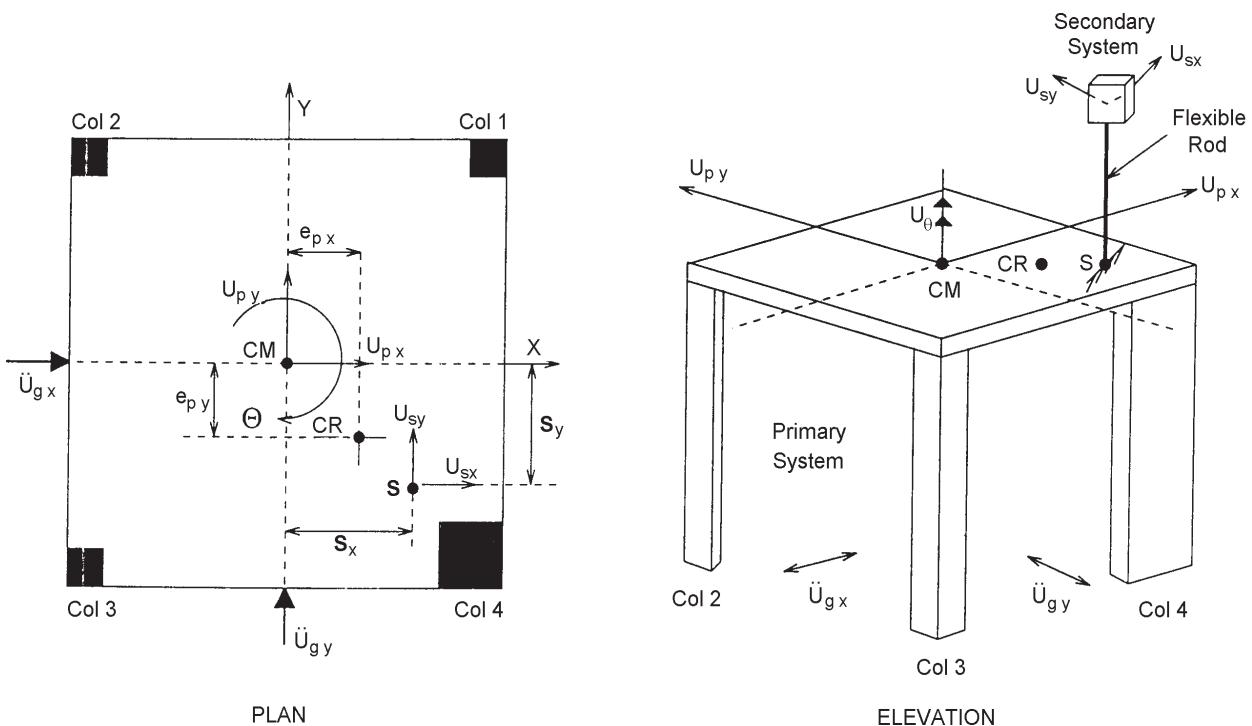

Figure 1. Structural model.

and the stiffness of the S-system in any direction is given by K_s .

Let r_i denote the distance of the i^{th} column from the center of mass (CM) of the P-system, then the total initial torsional stiffness of the P-system, defined about the CM, is given by

$$K_\theta = \sum_{i=1}^4 K_{pi} r_i^2 \quad (2)$$

in which it is assumed that the torsional stiffness of each of the individual column is negligible. The eccentricities of the P-system in the two orthogonal directions with respect to the CM of the P-system are given by Figure 1.

$$e_{px} = \frac{\sum_{i=1}^4 K_{pi} x_i}{\sum_{i=1}^4 K_{pi}} \quad (3)$$

$$e_{py} = \frac{\sum_{i=1}^4 K_{pi} y_i}{\sum_{i=1}^4 K_{pi}} \quad (4)$$

in which x_i and y_i are the X and Y coordinates of the i^{th} column with respect to the CM of the P-system. Eccentricities of the S-system (e_{sx} and e_{sy}) are taken to be variables for the parametric study. The two uncoupled frequency parameters of the P-system are defined as

$$\omega_p = \sqrt{\frac{K_p}{m_p}} \quad (5)$$

and

$$\omega_\theta = \sqrt{\frac{K_\theta}{m_p R^2}} \quad (6)$$

and natural frequency of the S-system is given by

$$\omega_s = \sqrt{\frac{K_s}{m_s}} \quad (7)$$

in which m_p and m_s are the masses of the primary and the secondary structural systems respectively, and R is the radius of gyration of the primary mass about the vertical axis through the CM. The frequencies ω_p and ω_θ may be interpreted as the natural frequencies of the P-system, based on the initial stiffness, if they were torsionally uncoupled, i.e. a system with e_{px} and $e_{py} = 0$, but m_p , K_p and K_θ are the same as those in the coupled system. The mass ratio ρ is defined as $\rho = m_s/m_p$. The values of K_p and m_p are varied to provide different values of the frequency parameters (ω_p and ω_θ) in the analysis. All

these parameters are taken to be the same in both x and y directions.

3. EQUATIONS OF MOTION FOR THE COMBINED SYSTEM

The equation of motion of the hysteretic primary and the linear secondary structural systems to bi-directional input excitation may be written as

$$[M]\{\ddot{U}\} + [C]\{\dot{U}\} + \{F\} = -[M][I]\{\ddot{U}_g\} = f(\theta) \quad (8)$$

where $\{U\} = \{U_{px}, U_{py}, U_\theta, U_{sx}, U_{sy}\}^T$ is the displacement vector of the system model; $[I]$, $[M]$ and $[C]$ are termed as influencing coefficient, mass and damping matrices respectively and $\{\ddot{U}_g\} = \{\ddot{U}_{gx}, \ddot{U}_{gy}\}^T$ is the ground acceleration vector. The matrices $[I]$, $[M]$ and $[C]$ are given by

$$[I] = \begin{bmatrix} 1 & 0 & 0 & 1 & 0 \\ 0 & 1 & 0 & 0 & 1 \end{bmatrix}^T \quad (9)$$

$$[M] = \text{diag}[m_p, m_p, m_p R^2, m_s, m_s] \quad (10)$$

$$[C] = \begin{bmatrix} \sum C_{pi} + C_s & 0 & \sum C_{p\theta x} + C_s e_{sy} \\ 0 & \sum C_{pi} + C_s & \sum C_{p\theta y} + C_s e_{sx} \\ \sum C_{\theta px} + C_s e_{sy} & \sum C_{\theta py} + C_s e_{sx} & C_\theta + C_s (e_{sx}^2 + e_{sy}^2) \\ -C_s & 0 & -C_s e_{sy} \\ 0 & -C_s & -C_s e_{sx} \\ -C_s & 0 \\ 0 & -C_s \\ -C_s e_{sy} & -C_s e_{sx} \\ C_s & 0 \\ 0 & -C_s \end{bmatrix} \quad (11)$$

where $\sum C_{pi}$, $\sum C_{p\theta x} = \sum C_{\theta px}$, $\sum C_{p\theta y} = \sum C_{\theta py}$ and C_θ are the elements of the damping matrix neglecting the S-system; $C_s = 2 \xi_s m_s \omega_s$ is the damping of the S-system; and ξ_s is the percentage critical damping. The elements of the damping matrix, concerning the P-system, are determined by assuming that the damping matrix of the P-system is proportional to its mass and initial stiffness matrices. Using the modal damping ratio, and the first two undamped mode shapes of the P-system (only), these elements are obtained by standard procedure [14].

The restoring force vector $\{F\} = \{f_1, f_2, f_3, f_4, f_5\}^T$, Eq. (8), is given in the Appendix (I). The total displacements (U_x and U_y) of the P-system consist of both hysteretic and linear components. The hysteretic components Z_j ($j = x, y$) for the column elements are given by the following first order non-linear differential equations [13].

$$\begin{aligned} \dot{Z}_x &= A\dot{U}_x - \beta \text{sgn}(\dot{U}_x) |Z_x| Z_x - \gamma \dot{U}_x Z_x^2 \\ &\quad - \beta \text{sgn} \dot{U}_y |Z_y| Z_x - \gamma \dot{U}_y Z_x Z_y \end{aligned} \quad (12)$$

and

$$\begin{aligned} \dot{Z}_y &= A\dot{U}_y - \beta \operatorname{sgn}(\dot{U}_y) |Z_y| Z_y - \gamma \dot{U}_y Z_y^2 \\ &\quad - \beta \operatorname{sgn} \dot{U}_x |Z_x| Z_y - \gamma \dot{U}_x Z_y Z_x \end{aligned} \quad (13)$$

in which γ, β , and A are the hysteretic parameters. The parameters γ and β control the shape of the hysteretic loop, and A is the restoring force amplitude which controls both stiffness and strength. For nearly elasto plastic system, the hysteretic parameters are taken as $A=1.0$, and $\gamma=\beta=0.5$ [3].

Using the equivalent linearization procedure [17], the hysteretic Eqs. (12 and 13) can be linearized as

$$\dot{Z}_x + C_x [(\dot{U}_{px} + \dot{U}_\theta e_{py}) - \dot{Z}_x] + C'_x Z_x = 0 \quad (14)$$

$$\dot{Z}_y + C_y [(\dot{U}_{py} + \dot{U}_\theta e_{px}) - \dot{Z}_y] + C'_y Z_y = 0 \quad (15)$$

the expressions for the parameters C_x, C'_x etc. are given in the Appendix (III).

The linearized equation of motion of the combined structural system which includes hysteretic elements also is given by combining the Eqs. (8, 14, and 15)

$$[\bar{M}] \{\ddot{V}\} + [\bar{C}] \{\dot{V}\} + [\bar{K}] \{V\} = -[\bar{M}][\bar{I}] \{\ddot{U}_g\} \quad (16)$$

where the displacement vector of the system model is given by $\{V\} = \{U_{px}, U_{py}, U_\theta, U_{sx}, U_{sy}, Z_x, Z_y\}^T$ and $[\bar{I}]$ and $[\bar{M}]$ are expressed as

$$[\bar{I}] = \begin{bmatrix} 1 & 0 & 0 & 1 & 0 & 0 & 0 \\ 0 & 1 & 0 & 0 & 1 & 0 & 0 \end{bmatrix}^T \quad (17)$$

and

$$[\bar{M}] = \operatorname{diag} [m_p, m_p, m_p R^2, m_s, m_s, 0, 0] \quad (18)$$

the matrices $[\bar{C}]$ and $[\bar{K}]$ are given in the Appendix (I).

4. EQUATIONS OF MOTION FOR THE CASCADED SYSTEM

The equation of motion for the hysteretic P-system, without considering interaction between the PS-system, may be written as

$$[M_1] \{\dot{U}_1\} + [C_1] \{U_1\} + \{F_1\} = -[M_1][I_1] \{\ddot{U}_{gj}\} = f_1(t) \quad (19)$$

where the displacement vector $\{U_1\}$ is given by $\{U_1\} = \{U_{1px}, U_{1py}, U_{1\theta}\}^T$ and matrices $[I_1], [M_1]$, and $[C_1]$ are expressed as

$$[I_1] = \begin{bmatrix} 1 & 0 & 0 \\ 0 & 1 & 0 \end{bmatrix}^T \quad (20)$$

$$[M_1] = \operatorname{diag} [m_p, m_p, m_p R^2] \quad (21)$$

$$[C_1] = \begin{bmatrix} \sum C_{pi} & 0 & \sum C_{p\theta x} \\ 0 & \sum C_{pi} & \sum C_{p\theta y} \\ \sum C_{\theta px} & \sum C_{\theta py} & C_\theta \end{bmatrix} \quad (22)$$

The restoring force vector of the P-system $\{F_1\} = \{f_{11}, f_{12}, f_{13}\}^T$ for the no-interaction case is given in the Appendix (II). The hysteretic components Z_{ij} ($j = x, y$), from the hysteretic force deformation relationship is expressed as

$$\begin{aligned} \dot{Z}_{1x} &= A\dot{U}_{1x} - \beta \operatorname{sgn}(\dot{U}_{1x}) |Z_{1x}| Z_{1x} - \gamma \dot{U}_{1x} Z_{1x}^2 \\ &\quad - \beta \operatorname{sgn} \dot{U}_{1y} |Z_{1y}| Z_{1x} - \gamma \dot{U}_{1y} Z_{1x} Z_{1y} \end{aligned} \quad (23)$$

and

$$\begin{aligned} \dot{Z}_{1y} &= A\dot{U}_{1y} - \beta \operatorname{sgn}(\dot{U}_{1y}) |Z_{1y}| Z_{1y} - \gamma \dot{U}_{1y} Z_{1y}^2 \\ &\quad - \beta \operatorname{sgn} \dot{U}_{1x} |Z_{1x}| Z_{1y} - \gamma \dot{U}_{1x} Z_{1y} Z_{1x} \end{aligned} \quad (24)$$

The linearized equation of motion of the P-system is given by

$$[\bar{M}_1] \{\ddot{V}_1\} + [\bar{C}_1] \{\dot{V}_1\} + [\bar{K}_1] \{V_1\} = -[\bar{M}_1][\bar{I}_1] \{\ddot{U}_{gj}\} \quad (25)$$

The displacement vector is given by $\{V_1\} = \{U_{1px}, U_{1py}, U_{1\theta}, Z_{1x}, Z_{1y}\}^T$ and $\{\bar{I}_1\}$ and $\{\bar{M}_1\}$ are expressed as

$$\{\bar{I}_1\} = \begin{bmatrix} 1 & 0 & 0 & 0 & 0 \\ 0 & 1 & 0 & 0 & 0 \end{bmatrix}^T \quad (26)$$

and

$$\{\bar{M}_1\} = \operatorname{diag} [m_p, m_p, m_p R^2, 0, 0] \quad (27)$$

the matrices $\{\bar{C}_1\}$ and $\{\bar{K}_1\}$ are given in the Appendix (II).

The equation of motion for the secondary (SDOF) system is given as

$$[m] \{\ddot{w}\} + [c] \{\dot{w}\} + [k] \{w\} = -[m][i] \{\ddot{U}_{apj}\} \quad (28)$$

where $\{w\} = \{w_{sx}, w_{sy}\}^T$ is the displacement vector of the SDOF system; $\{\ddot{U}_{apj}\} = \{\ddot{U}_{apx}, \ddot{U}_{apy}\}^T$ is the acceleration vector for the deck of the P-system, at the point of attachment of the SDOF system along the two orthogonal directions (x and y); and $[i], [m], [c]$ and $[k]$ are termed as influencing coefficient, mass, damping and stiffness matrices respectively for the SDOF system. These matrices are given by

$$[i] = \begin{bmatrix} 1 & 0 \\ 0 & 1 \end{bmatrix} \quad (29)$$

$$[m] = \begin{bmatrix} m_s & 0 \\ 0 & m_s \end{bmatrix} \quad (30)$$

$$[c] = \begin{bmatrix} C_s & 0 \\ 0 & C_s \end{bmatrix} \quad (31)$$

and

$$[k] = \begin{bmatrix} K_s & 0 \\ 0 & K_s \end{bmatrix} \quad (32)$$

5. SPECTRAL ANALYSIS FOR THE LINEARIZED SYSTEM

5.1. Combined PS-system

The frequency response function matrix $[H(\omega)]$ for the composite PS-system is given by

$$[H(\omega)] = \left(-\omega^2 [\bar{M}] + i\omega [\bar{C}] + [\bar{K}] \right)^{-1} \quad (33)$$

If the power spectral density function (PSDF) of the input excitation is modelled as a stationary random process, then the PSDF of the displacement is given by

$$[S_U(\omega)] = [H(\omega)] [S_f(\omega)] [H(\omega)]^{*T} \quad (34)$$

in which $[S_f(\omega)]$ is the PSDF matrix of the $f(t)$ and is given in the Appendix (I).

The relative displacements (U_{rx} and U_{ry}) and the absolute accelerations ($\ddot{U}_{aj} \dots j = x, y$) of the S-system are obtained in the following manner

$$U_{rx} = U_{sx} - U_{px} - U_{\theta} e_{sy} \quad (35)$$

$$U_{ry} = U_{sy} - U_{py} - U_{\theta} e_{sx} \quad (36)$$

and

$$\ddot{U}_{aj} = \ddot{U}_{sj} + \ddot{U}_{gj} \quad (37)$$

Thus, the PSDFs of the relative displacements and the absolute acceleration ($S_{U_{rx}}, S_{U_{ry}}$ and $S_{\ddot{U}_{aj}}$) are given by

$$S_{U_{rx}} = S_{U_{px}} + e_{sy}^2 S_{U_{\theta}} + S_{U_{sx}} + e_{sy} S_{U_{px} U_{\theta}} + e_{sy} S_{U_{\theta} U_{px}} - S_{U_{px} U_{sx}} - S_{U_{sx} U_{px}} - e_{sy} S_{U_{sx} U_{\theta}} - e_{sy} S_{U_{\theta} U_{sx}} \quad (38)$$

$$S_{U_{ry}} = S_{U_{py}} + e_{sx}^2 S_{U_{\theta}} + S_{U_{sy}} + e_{sx} S_{U_{py} U_{\theta}} + e_{sx} S_{U_{\theta} U_{py}} - S_{U_{py} U_{sy}} - S_{U_{sy} U_{py}} - e_{sx} S_{U_{sy} U_{\theta}} - e_{sx} S_{U_{\theta} U_{sy}} \quad (39)$$

and

$$S_{\ddot{U}_{aj}} = S_{\ddot{U}_{sj}} + S_{\ddot{U}_{gj}} + S_{\ddot{U}_{gj} \ddot{U}_{sj}} + S_{\ddot{U}_{sj} \ddot{U}_{gj}} \quad (40)$$

The elements of the right hand side (RHS) of Eqs. (38 and 39) can directly be obtained from the PSDF matrix of the displacement of the combined structural system Eq. (34). The elements of the RHS of the Eq. (40) are derived as

$$S_{\ddot{U}_{sj}} = \omega^4 S_{U_{sj}} \quad (41)$$

$$S_{\ddot{U}_{sx} \ddot{U}_{gx}} = [H_{41}] S_{\ddot{U}_{gx}} \quad (42)$$

$$S_{\ddot{U}_{sy} \ddot{U}_{gy}} = [H_{52}] S_{\ddot{U}_{gy}} \quad (43)$$

$$S_{\ddot{U}_{gx} \ddot{U}_{sx}} = [H_{41}^*] S_{\ddot{U}_{gx}} \quad (44)$$

$$S_{\ddot{U}_{gy} \ddot{U}_{sy}} = [H_{52}^*] S_{\ddot{U}_{gy}} \quad (45)$$

where $[H_{41}]$ and $[H_{52}]$ are the elements of the $[H(\omega)]$ matrix. The variances of the response quantities are obtained as

$$\sigma_{U_{rj}}^2 = \int_{-\infty}^{+\infty} S_{U_{rj}}(\omega) d\omega \quad (46)$$

$$\sigma_{\ddot{U}_{aj}}^2 = \int_{-\infty}^{+\infty} S_{\ddot{U}_{aj}}(\omega) d\omega \quad (47)$$

5.2. Cascaded System

The frequency response function matrix for the P-system is given by

$$[H_1(\omega)] = \left(-\omega^2 [\bar{M}_1] + i\omega [\bar{C}_1] + [\bar{K}_1] \right)^{-1} \quad (48)$$

Frequency response function $H_s(\omega)$ for the secondary system is given by

$$H_s(\omega) = \left(-M_s \omega^2 + iC_s \omega + K_s \right)^{-1} \quad (49)$$

The input floor acceleration \ddot{U}_{aj} at the point of attachment of the secondary system is given by

$$\ddot{U}_{aj} = \ddot{U}_{pj} + \ddot{U}_{gj} + \ddot{U}_{\theta} e_s \quad (50)$$

The PSDF of the absolute acceleration ($S_{\ddot{U}_{aj}}$) of the P-system is given by

$$S_{\ddot{U}_{aj}} = S_{\ddot{U}_{pj}} + S_{\ddot{U}_{gj}} + S_{\ddot{U}_{gj} \ddot{U}_{pj}} + S_{\ddot{U}_{pj} \ddot{U}_{gj}} \quad (51)$$

The elements of the (RHS) of the Eq. (51), are derived as ($j = x, y$)

$$S_{\ddot{U}_{pj}} = \omega^4 S_{U_{pj}} \quad (52)$$

$$S_{\ddot{U}_{px} \ddot{U}_{gx}} = [H_{1,11}] S_{\ddot{U}_{gx}} \quad (53)$$

$$S_{\ddot{U}_{py} \ddot{U}_{gy}} = [H_{1,22}] S_{\ddot{U}_{gy}} \quad (54)$$

$$S_{\ddot{U}_{px} \ddot{U}_{sx}} = [H_{1,11}^*] S_{\ddot{U}_{gx}} \quad (55)$$

$$S_{\ddot{U}_{py} \ddot{U}_{sy}} = [H_{1,22}^*] S_{\ddot{U}_{gy}} \quad (56)$$

where $[H_{1,11}]$ and $[H_{1,22}]$ are the elements of the $[H_1(\omega)]$ matrix Eq. (48).

The relative displacement between the S-system and P-system is obtained as

$$[S_{U_j}(\omega)] = [H_s(\omega)] [S_{f_s}(\omega)] [H_s(\omega)]^{*T} \quad (57)$$

in which

$$[S_{f_s}(\omega)] = \begin{bmatrix} m_s^2 & 0 \\ 0 & m_s^2 \end{bmatrix} S_{\ddot{U}_{aj}}(\omega) \quad (58)$$

The absolute acceleration \ddot{U}_{asj} of the S-system is given as

$$\ddot{U}_{asj} = \ddot{U}_{sj} + \ddot{U}_{aj} \quad (59)$$

The PSDF of the absolute acceleration ($S_{\ddot{U}_{asj}}$) of the S-system is given by

$$S_{\ddot{U}_{asj}} = S_{\ddot{U}_{sj}} + S_{\ddot{U}_{aj}} + S_{\ddot{U}_{aj}} \ddot{U}_{sj} + S_{\ddot{U}_{sj}} \ddot{U}_{aj} \quad (60)$$

The elements of the RHS of the Eq. (60) are derived as

$$S_{\ddot{U}_{sj}} = \omega^4 S_{U_{sj}} \quad (61)$$

$$S_{\ddot{U}_{sx} \ddot{U}_{ax}} = [H_{s,11}] S_{\ddot{U}_{ax}} \quad (62)$$

$$S_{\ddot{U}_{sy} \ddot{U}_{ay}} = [H_{s,22}] S_{\ddot{U}_{ay}} \quad (63)$$

$$S_{\ddot{U}_{ax} \ddot{U}_{ax}} = [H_{s,11}^*] S_{\ddot{U}_{ax}} \quad (64)$$

$$S_{\ddot{U}_{ay} \ddot{U}_{ay}} = [H_{s,22}^*] S_{\ddot{U}_{ay}} \quad (65)$$

where $[H_{s,11}]$ and $[H_{s,22}]$ are the elements of the $[H_s(\omega)]$ matrix for the SDOF system.

6. TIME DOMAIN ANALYSIS FOR THE NON-LINEAR SYSTEM

6.1. Combined PS-system

The restoring force vector $\{F\}$ of the Eq. (8) is given by [Clough and Penzien [7]]

$$\{F\} = [K_\alpha]\{U\} + [H_\alpha]\{Z\} \quad (66)$$

where $[K_\alpha]$ is the stiffness matrix of the PS-system which includes the effect of non-linearity of the P-system without considering hysteretic effect and $[H_\alpha]$ is the hysteretic stiffness matrix of the P-system.

The matrices $[K_\alpha]$ and $[H_\alpha]$ are given in the Appendix (I). The hysteretic components $\{Z_j\}$ ($j = x, y$) for the non-linear P-system at any particular time t are given by Eqs. (12 and 13).

In the time domain method of analysis, the equation of motion of the PS-system, Eq. (8) can be solved by incremental solution choosing suitable time step (Δt) for integration. The resulting incremental effective static equilibrium equation can be expressed as

$$[\tilde{K}]\{\Delta U\} = \{\Delta \tilde{P}\} \quad (67)$$

and

$$[H_\alpha]\{\Delta Z\} = \{\Delta f_h(t)\} \quad (68)$$

The expression for the effective stiffness matrix can be written as

$$[\tilde{K}] = [K_\alpha] + \frac{3[C]}{\Delta t} + \frac{6[M]}{(\Delta t)^2} \quad (69)$$

and the effective load increment for any time t is given by

$$\begin{aligned} \{\Delta \tilde{P}\} = & \{\Delta f(t)\} - \{\Delta f_h(t)\} + [M] \left(\frac{6}{\Delta t} \{\dot{U}_t\} + 3 \{\ddot{U}_t\} \right) \\ & + [C] \left(3 \{\dot{U}_t\} + \frac{\Delta t}{2} \{\ddot{U}_t\} \right) \end{aligned} \quad (70)$$

After the calculation of incremental displacement $\{\Delta U\}$ from the Eq. (67), the incremental velocity $\{\Delta \dot{U}\}$ may be calculated as

$$\{\Delta \dot{U}\} = \frac{3}{(\Delta t)} \{\Delta U\} - 3 \{\dot{U}_t\} - \frac{\Delta t}{2} \{\ddot{U}_t\} \quad (71)$$

and the acceleration at that time t , $\{\ddot{U}(t)\}$ is calculated as

$$\{\ddot{U}(t)\} = \frac{1}{[M]} (\{f_t\} - \{f_D\} - \{f_{K\alpha}\} - \{f_h\}) \quad (72)$$

where $\{\Delta f(t)\}$ is the increment in the earthquake excitation force and $\{\Delta f_h(t)\}$ is the incremental hysteretic force between time t and $t + \Delta t$; $\{f_t\} = [M]\{\ddot{U}\}$ is the inertial force; $\{f_D\} = [C]\{\dot{U}\}$ is the damping force; $\{f_{K\alpha}\} = [K_\alpha]\{U\}$ is the stiffness force without considering hysteretic effect; and $\{f_h\} = [H_\alpha]\{Z\}$ is the hysteretic force. All the above forces are calculated at any time t for the calculation of the acceleration at that time.

The relative displacement $U_r(t)$ and the absolute acceleration $\ddot{U}_a(t)$ of the S-system are obtained as

$$U_{rx}(t) = U_{sx}(t) - U_{px}(t) - U_\theta(t) e_{sy} \quad (73)$$

$$U_{ry}(t) = U_{sy}(t) - U_{py}(t) - U_\theta(t) e_{sx} \quad (74)$$

and

$$\ddot{U}_{aj}(t) = \ddot{U}_{sj}(t) + \ddot{U}_{gj}(t) \quad \dots (j = x, y) \quad (75)$$

6.2. Cascaded System

The restoring force $\{F_1\}$ vector for the P-system Eq. (19) is given by

$$\{F_1\} = [K_{1\alpha}]\{U_1\} + [H_{1\alpha}]\{Z_1\} \quad (76)$$

where $[K_{1\alpha}]$ and $[H_{1\alpha}]$ are given in the Appendix (II). The Eq. (76) is solved in the same manner as described before. The absolute acceleration of the P-system $\ddot{U}_{apj}(t)$ ($j = x, y$), at the point of attachment of the S-system is given by

$$\ddot{U}_{apx}(t) = \ddot{U}_{px}(t) + \ddot{U}_{\theta p}(t) e_{sy} + \ddot{U}_{gx} \quad (77)$$

and

$$\ddot{U}_{apy}(t) = \ddot{U}_{py}(t) + \ddot{U}_{\theta p}(t) e_{sx} + \ddot{U}_{gy} \quad (78)$$

The S-system is analyzed with the absolute acceleration time history given by Eqs. (77 and 78). The integration of the equation of motion is performed by Newmark's beta method [14]. The result of the integration provides the relative displacement between the S-system and the P-system. The absolute acceleration of the SDOF system $\ddot{U}_{asj}(t)$ is given by ($j = x, y$)

$$\ddot{U}_{asj}(t) = \ddot{U}_{sj}(t) + \ddot{U}_{apj}(t) \tag{79}$$

7. PARAMETRIC STUDY

A large number of parameters influence the responses of the P-system absolute acceleration ($\sigma_{\ddot{x}_a}/g$) and the relative displacement (σ_{x_r}) of the S-system. The important parameters, which predominantly influence the responses are considered in the present study. These parameters include the normalized eccentricities of the P-system (e_{px}/R and e_{py}/R) and the S-system (e_{sx}/R and e_{sy}/R) in two orthogonal directions (x and y); the uncoupled lateral frequencies of the P-system (ω_p) and the S-system (ω_s); the damping ratios of the P-system (ξ_p) and the S-system (ξ_s); the ratio of uncoupled lateral to rotational frequencies (ω_p/ω_h) of the P-system; and the mass ratio m_s/m_p of the PS-system. Values of other parameters (held constant throughout) are $\omega_p = 3.0 \text{ rad/sec}$, $\xi_p = 5.0\%$, $\xi_s = 2.0\%$, and $R = 3.0$ meters. The hysteretic parameters of the primary structural system are taken as $A = 1.0$, $\gamma = \beta = 0.5$, and $\alpha = 1/21$ (for nearly elasto-plastic case). Intensity of the white noise input excitation is the same in both x and y directions and is taken as $0.013 \text{ m}^2/\text{sec}/\text{rad}$. The time history of ground acceleration is simulated from the PSDF of white noise for a record length of 200 seconds.

7.1. Effect of the Degree of Non-linearity in the P-system

Figures 2 and 3 show the variation of responses with normalized eccentricities of the P-systems with hysteretic parameter α for strong and weak torsionally coupled P-system under both the tuned and untuned conditions. For strong torsionally coupled P-system under the tuned condition, the responses increase with the increase in α . This indicates that the responses decrease as the non-linearity of the P-system increases. However, an opposite trend is observed for the weak torsionally coupled P-system under the untuned condition.

7.2. Effect of Linearization

Solution of the equation of motion Eq. (8) by equivalent linearization technique (frequency domain spectral analysis) gives approximate responses for the S-system. The time domain solution takes into account the full non-linearity of the P-system. Thus the time domain method gives more accurate responses. From Figures 4 to 7, and Figures 14 and 15, it is observed that the maximum

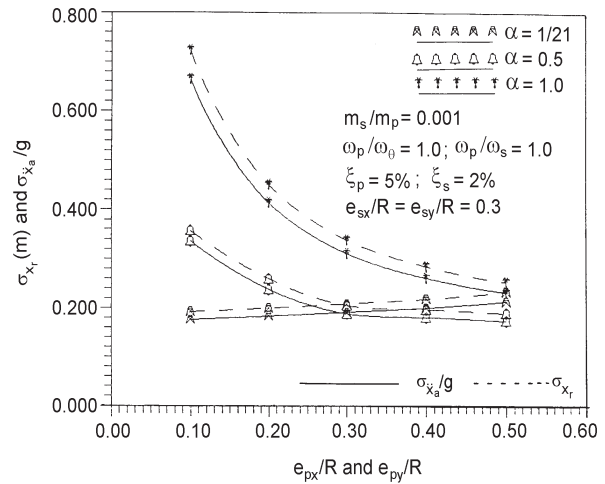

Figure 2. Variation of responses with e_{px}/R and e_{py}/R for different values of α , and for $\omega_p/\omega_0 = 1.0$ and $\omega_p/\omega_s = 1.0$.

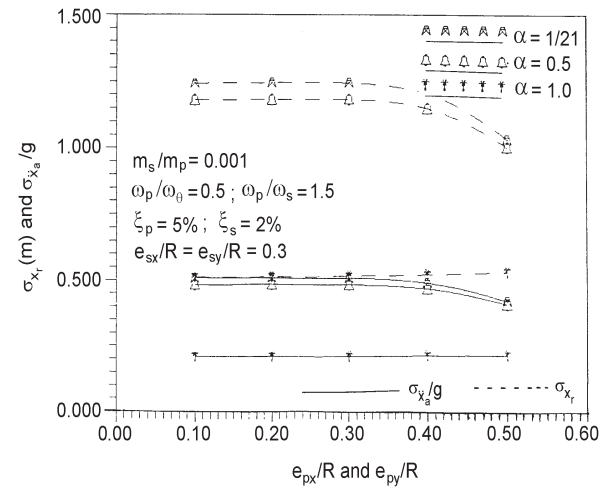

Figure 3. Variation of responses with e_{px}/R and e_{py}/R for different values of α , and for $\omega_p/\omega_0 = 0.5$ and $\omega_p/\omega_s = 1.5$.

difference in responses between the equivalent linearization technique and the time integration technique is not very large and is of the order of 14%. In certain cases, the linearized method provides higher responses (e.g. variation of the responses with e_{px}/R and e_{py}/R for both strong and weak torsionally coupled P-systems under the untuned condition, (see Figures 5 and 7), while for other cases, it provides less response e.g. variation of the responses with e_{px}/R and e_{py}/R for strong and weak torsionally coupled P-system under the tuned condition, (see Figures 4 and 6). Further, for strong and weak torsionally coupled P-system under the tuned condition, the responses increase with the increase in e_{px}/R and e_{py}/R as shown in Figures 4 and 6. However, an opposite trend is observed for strong and weak torsionally coupled P-system under the untuned condition, (see Figures 5 and 7).

7.3. Effect of Primary-Secondary Interaction

Figures 8 to 11 show the effect of interaction between the

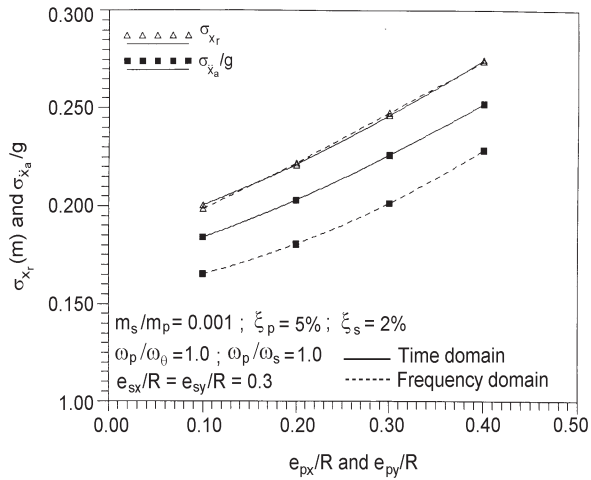

Figure 4. Variation of responses with e_{px}/R and e_{py}/R for $\omega_p/\omega_\theta = 1.0$ and $\omega_p/\omega_s = 1.0$.

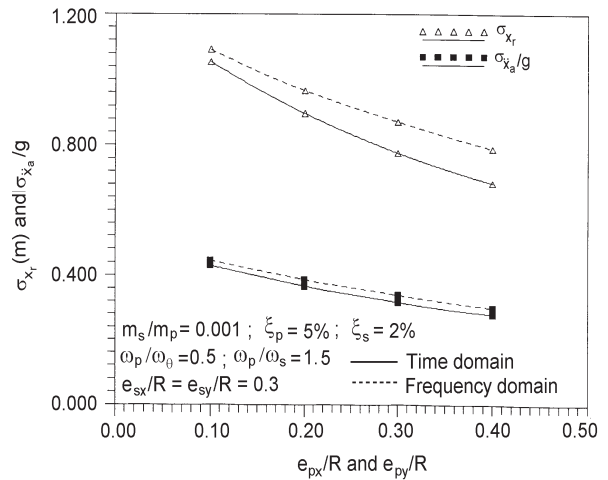

Figure 7. Variation of responses with e_{px}/R and e_{py}/R for $\omega_p/\omega_\theta = 0.5$ and $\omega_p/\omega_s = 1.5$.

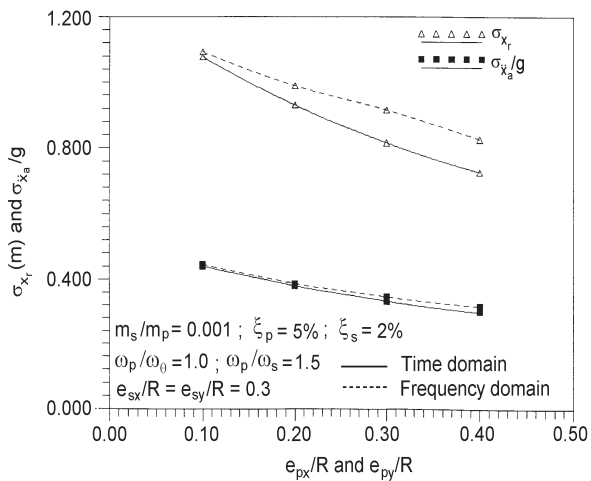

Figure 5. Variation of responses with e_{px}/R and e_{py}/R for $\omega_p/\omega_\theta = 1.0$ and $\omega_p/\omega_s = 1.5$.

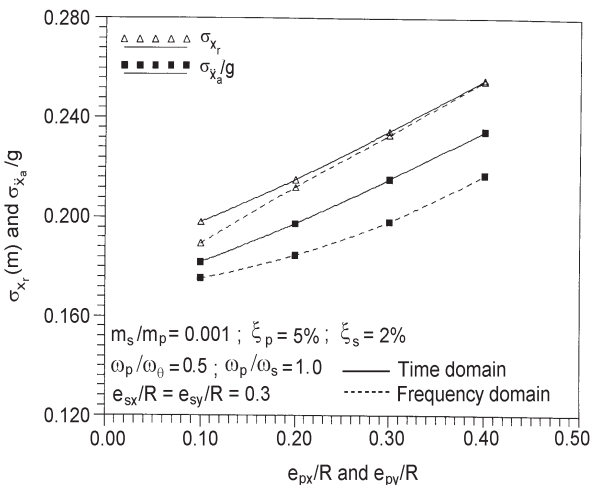

Figure 6. Variation of responses with e_{px}/R and e_{py}/R for $\omega_p/\omega_\theta = 0.5$ and $\omega_p/\omega_s = 1.0$.

primary and the secondary structural systems (PS-interaction) on the response quantities of interest.

Figures 8 and 9 show the variation of responses with normalized eccentricities of the P-system with and without

PS-interaction. Similarly, Figures 10 and 11 show the same variation with normalized eccentricities of the S-system. From the figures, it is observed that the PS-interaction provides higher responses. However, the nature of the variation of responses with the normalized eccentricities of the primary and the secondary system remains the same.

7.4. Effect of Mass Ratio (m_s/m_p)

Figures 12 and 13 show the effect of the m_s/m_p ratio on response quantities of interest. It is seen from the figures that the increase in the m_s/m_p ratio decreases the

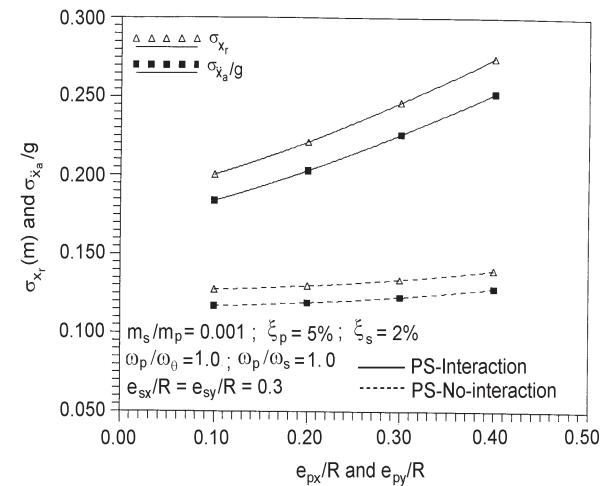

Figure 8. Variation of responses with e_{px}/R and e_{py}/R for $\omega_p/\omega_\theta = 1.0$ and $\omega_p/\omega_s = 1.0$, with and without PS-interaction.

responses. However, the change in m_s/m_p ratio does not change the nature of variation of responses with the normalized eccentricities.

7.5. Effect of Damping Ratio of the Secondary System

Figures 14 and 15 show the variations of the absolute acceleration with the damping ratio of the S-system (ξ_s) for the strong torsionally coupled P-system under both tuned

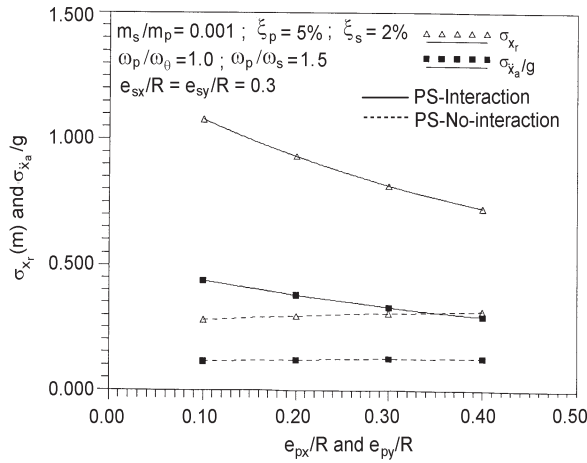

Figure 9. Variation of responses with e_{px}/R and e_{py}/R for $\omega_p/\omega_\theta = 1.0$ and $\omega_p/\omega_s = 1.5$, with and without PS-interaction.

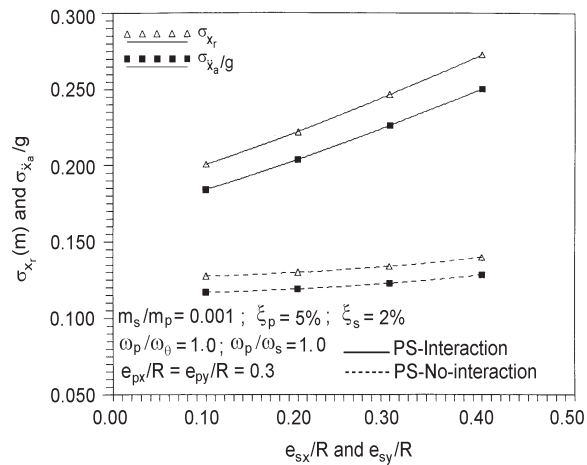

Figure 10. Variation of responses with e_{sx}/R and e_{sy}/R for $\omega_p/\omega_\theta = 1.0$ and $\omega_p/\omega_s = 1.0$, with and without PS-interaction.

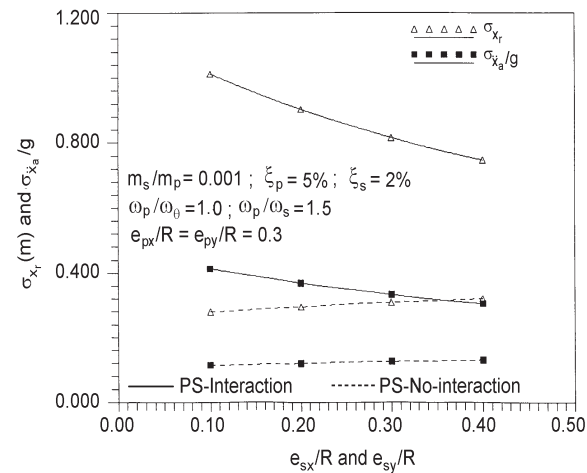

Figure 11. Variation of responses with e_{sx}/R and e_{sy}/R for $\omega_p/\omega_\theta = 1.0$ and $\omega_p/\omega_s = 1.5$, with and without PS-interaction.

and untuned conditions. The responses generally decrease with the increase in (ξ_s) . The responses decrease sharply in the lower range of (ξ_s) values.

7.6. Effect of Degree of Asymmetry of the P-system

Figures 4 and 6 show that the responses increase with increase in the degree of asymmetry for the tuned condition. On the contrary, Figures 5 and 7 show that under the untuned condition, responses decrease with the increase in the degree of asymmetry.

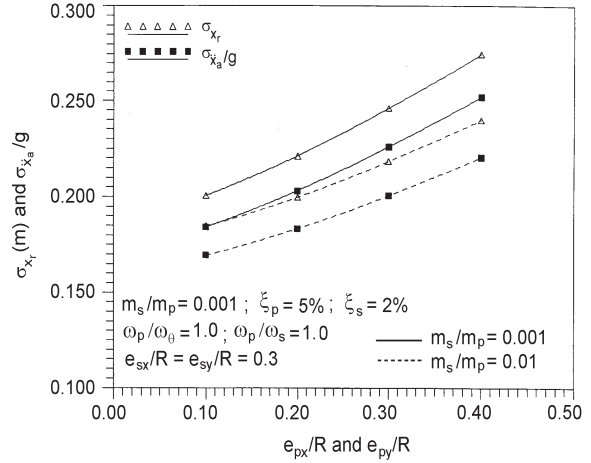

Figure 12. Variation of responses with e_{px}/R and e_{py}/R for different values of m_s/m_p (for $\omega_p/\omega_\theta = 1.0$ and $\omega_p/\omega_s = 1.0$).

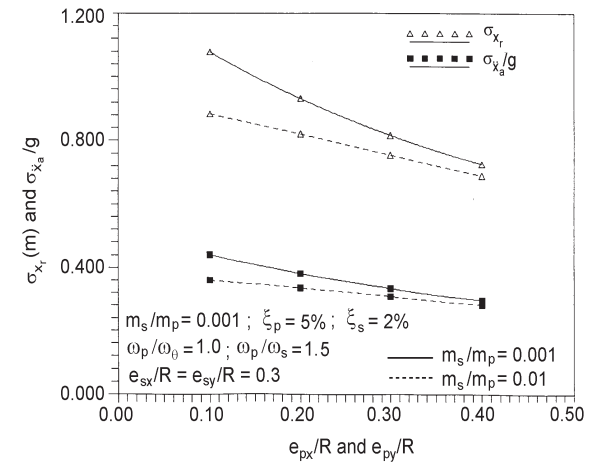

Figure 13. Variation of responses with e_{px}/R and e_{py}/R for different values of m_s/m_p (for $\omega_p/\omega_\theta = 1.0$ and $\omega_p/\omega_s = 1.5$).

8. CONCLUSIONS

Seismic behavior of a secondary structural system mounted over a torsionally coupled non-linear primary structural system is investigated under bi-directional random ground excitation, modelled as a white noise. The response quantities of interest are the standard deviation of the relative displacement between the primary and the secondary structural systems and the absolute acceleration of the secondary system. The responses are obtained by both linearized frequency domain analysis and time domain analysis. The effect of interaction between the primary and the secondary structural systems on

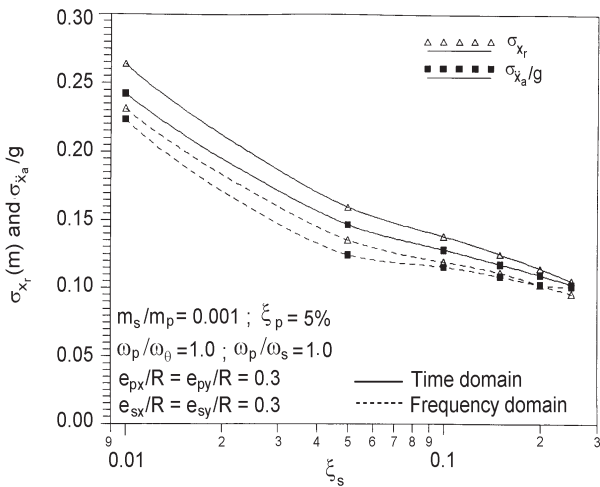

Figure 14. Variation of responses with ξ_s for $\omega_p/\omega_0 = 1.0$ and $\omega_p/\omega_s = 1.0$.

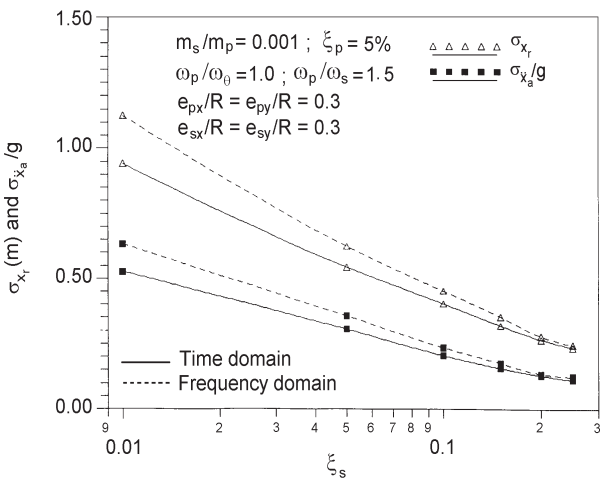

Figure 15. Variation of responses with ξ_s for $\omega_p/\omega_0 = 1.0$ and $\omega_p/\omega_s = 1.5$.

responses is also investigated by calculating responses of the cascaded system. The results of the study lead to the following conclusions:

- ❖ The difference between responses obtained by the linearized frequency domain analysis and the time domain simulation technique is not very large. The maximum difference is of the order of 14%.
- ❖ Under the tuned condition, responses increase with the increase in the degree of asymmetry i.e. e_{px}/R or e_{py}/R , of the P-system. However, an opposite trend is observed under the untuned condition.
- ❖ Similar results as above are observed for the variation of responses with normalized eccentricities of the S-system.
- ❖ Responses are found to be more when interaction is considered between the primary and the secondary structural systems.
- ❖ Responses decrease with the increase in the m_s/m_p ratio.
- ❖ Responses do not necessarily decrease with the

increase in the degree of non-linearity of the P-system. It depends upon the condition of tuning and the degree of torsional coupling.

- ❖ There is a sharp decrease in responses with the increase in ξ_s in the initial range of the ξ_s value; afterward, this variation tends to be flattened out.

REFERENCES

1. Agrawal, A.K., and Datta, T.K. (1997). "Behavior of Secondary System Attached to a Torsionally Coupled Primary System", *Journal of European Earthquake Engr.*, **2**, 47-53.
2. Agrawal, A.K., and Datta, T.K. (1997). "Non-linear Response of Secondary System due to Yielding of Torsionally Coupled Primary System", *Journal of European Earthquake Engr.*, In press.
3. Baber, T.T., and Wen, Y.K. (1981). "Random Vibration of Hysteretic Degrading Systems", *J. Engr. Mech., ASCE*, **107**(6), 1069-1087.
4. Chen, Y.O., and Soong, T.T. (1989). "Stochastic Response Sensitivity of Secondary System to Primary Structural Uncertainties", *Struct. Saf.*, **6**(2), 311-321.
5. Chen, D.C.K., and Lutes, L.D. (1990). "Non-normal Secondary Response due to Yielding in a Primary Structure", Tech. Rep. NCEER-90-0002, Nat. Ctr. for Eq. Engr. Res., Buffalo, N.Y.
6. Chen, D.C.K., and Lutes, L.D. (1994). "First-passage Time of Secondary System Mounted on Yielding Structure", *J. Engr. Mech., ASCE*, 814-834.
7. Clough, R.W., and Penzien, J. (1993). "Dynamics of Structures", McGraw-Hill, New York.
8. Huang, C.D., and Soong, T.T. (1994). "Stochastic Sensitivity Analysis of Nonlinear Primary-Secondary Structural Systems", *Engr. Structures*, 91-96.
9. Igusa, T. (1990). "Response Characteristics of Inelastic 2-DOF Primary-Secondary Structural System", *J. of Engr. Mech., ASCE*, 1160-1174.
10. Jangid, R.S., and Datta, T.K. (1993). "Spectral Analysis of Systems with Non-classical Damping Using Classical Mode Superposition Technique", *Earthquake Engineering and Structural Dynamics*, **22**, 723-735.
11. Kiureghian, A.D., Sackman, J.L., and Nour-Omid B. (1983). "Dynamic Analysis of Light Equipment in Structure: Response to Stochastic Input", *J. Engr. Mech. Div., ASCE*, 90-110.
12. Lin, J., and Mahin, S.A. (1985). "Seismic Response of Light Subsystem on Inelastic Structures." *J. Struct. Engr., ASCE*, **111**(2), 400-417.

13. Park, Y.J., Wen, Y.K., and Ang, H.S. (1986). "Random Vibration of Hysteretic Systems Under Bidirectional Ground Motions", *Earthquake Engineering and Structural Dynamics*, **14**, 543-557.
14. Paz, M. (1991). "Structural Dynamics Theory and Computation", Third Edition, "Van Nostrand Reinhold", New York.
15. Sewel, R.T., Cornell, C.A., Toro, G.R., and McGuire, R.K. (1986). "A Study of Factors Influencing Floor Response Spectra in Non-linear Multi-degree-of-freedom Structures", Report No. 82, John A. Blume Earthquake Engr. Ctr., Stanford Un., Stanford, Calif.
16. Suarez, L.E., and Singh, M.P. (1987). "Floor Response Spectra with Structure-equipment Interaction Effects by Mode Synthesis Approach", *Earthquake Engineering and Structural Dynamics*, **15**, 151-158.
17. Wen, Y.K. (1976). "Method for Random Vibration of Hysteretic Systems", *J. of Engr. Mech. Div.*, 249-263.
18. Yang, Y.B., and Huang, W.H. (1993). "Seismic Response of Light Equipment in Torsional Buildings", *Earthquake Engineering and Structural Dynamics*, **22**, 113-128.
19. Yang, Y.B., and Huang, W.H. (1998). "Equipment Structure Interaction Considering the Effect of Torsion and Base Isolation." *Earthquake Engineering and Structural Dynamics*, **27**, 155-171.

$$[K_{12}]_{5 \times 2} = \begin{bmatrix} \sum(1-2\alpha)K_{pi} & 0 \\ 0 & \sum(1-2\alpha)K_{pi} \\ \sum(1-2\alpha)K_{pi}y_i & \sum(1-2\alpha)K_{pi}x_i \\ 0 & 0 \\ 0 & 0 \end{bmatrix}$$

$$[K_{21}]_{2 \times 5} = \begin{bmatrix} 0 & 0 & 0 & 0 & 0 \\ 0 & 0 & 0 & 0 & 0 \end{bmatrix}$$

$$[K_{22}]_{2 \times 2} = \begin{bmatrix} C_x' & 0 \\ 0 & C_y' \end{bmatrix}$$

$$[C_{11}]_{5 \times 5} = \begin{bmatrix} \sum C_{pi} + C_s & 0 \\ 0 & \sum C_{pi} + C_s \\ \sum C_{pi}y_i + C_s e_{sy} & \sum C_{pi}x_i + C_s e_{sx} \\ -C_s & 0 \\ 0 & -C_s \end{bmatrix}$$

$$\begin{bmatrix} \sum C_{pi}y_i + C_s e_{sy} & -C_s & 0 \\ \sum C_{pi}x_i + C_s e_{sx} & 0 & -C_s \\ C_\theta + C_s(e_{sx}^2 + e_{sy}^2) & -C_s e_{sy} & -C_s e_{sx} \\ -C_s e_{sy} & C_s & 0 \\ -C_s e_{sx} & 0 & C_s \end{bmatrix}$$

$$[C_{12}]_{5 \times 2} = \begin{bmatrix} 0 & 0 \\ 0 & 0 \\ 0 & 0 \\ 0 & 0 \\ 0 & 0 \end{bmatrix}$$

$$[C_{21}]_{2 \times 5} = \begin{bmatrix} C_x & 0 & C_x e_{py} & 0 & 0 \\ 0 & C_y & C_y e_{px} & 0 & 0 \end{bmatrix}$$

$$[C_{22}]_{2 \times 2} = \begin{bmatrix} (1-C_x) & 0 \\ 0 & (1-C_y) \end{bmatrix}$$

$$\{F\}_{5 \times 1}^T = [[K_{11}] [K_{12}]]_{5 \times 7} \{U_{px} U_{py} U_\theta U_{sx} U_{sy} Z_x Z_y\}_{7 \times 1}^T$$

Appendix I

The matrices $[\bar{C}]$ and $[\bar{K}]$ of Eq. (16) are given as

$$[\bar{K}]_{7 \times 7} = \begin{bmatrix} [K_{11}]_{5 \times 5} & [K_{12}]_{5 \times 2} \\ [K_{21}]_{2 \times 5} & [K_{22}]_{2 \times 2} \end{bmatrix}$$

and

$$[\bar{C}]_{7 \times 7} = \begin{bmatrix} [C_{11}]_{5 \times 5} & [C_{12}]_{5 \times 2} \\ [C_{21}]_{2 \times 5} & [C_{22}]_{2 \times 2} \end{bmatrix}$$

where

$$[\bar{K}_{11}]_{5 \times 5} = \begin{bmatrix} \sum \alpha K_{pi} + K_s & 0 \\ 0 & \sum \alpha K_{pi} + K_s \\ \sum \alpha K_{pi}y_i + K_s e_{sy} & \sum \alpha K_{pi}x_i + K_s e_{sx} \\ -K_s & 0 \\ 0 & -K_s \end{bmatrix}$$

$$\begin{bmatrix} \sum \alpha K_{pi}y_i + K_s e_{sy} & -K_s & 0 \\ \sum \alpha K_{pi}x_i + K_s e_{sx} & 0 & -K_s \\ \sum \alpha K_{pi}(x_i^2 + y_i^2) + K_s(e_{sx}^2 + e_{sy}^2) & -K_s e_{sy} & -K_s e_{sx} \\ -K_s e_{sy} & K_s & 0 \\ -K_s e_{sx} & 0 & K_s \end{bmatrix}$$

The matrices $[K_\alpha]$ and $[H_\alpha]$ of Eq. (66) are expressed as

$$[K_\alpha] = [K_{11}]$$

$$[H_\alpha] = [K_{12}]$$

The matrix $[S_f(\omega)]$ of Eq. (34) is given as

$$[S_f(\omega)]_{7 \times 7} = \begin{bmatrix} m_p^2 & 0 & 0 & m_p m_s & 0 & 0 & 0 \\ 0 & m_p^2 & 0 & 0 & m_p m_s & 0 & 0 \\ 0 & 0 & 0 & 0 & 0 & 0 & 0 \\ m_p m_s & 0 & 0 & m_s^2 & 0 & 0 & 0 \\ 0 & m_p m_s & 0 & 0 & m_s^2 & 0 & 0 \\ 0 & 0 & 0 & 0 & 0 & 0 & 0 \\ 0 & 0 & 0 & 0 & 0 & 0 & 0 \end{bmatrix} S_{\ddot{u}_g}(\omega)$$

i=1,4

Appendix II

The matrices $[\bar{C}_1]$ and $[\bar{K}_1]$ of Eq. (25) are given as

$$[\bar{K}]_{5 \times 5} = \begin{bmatrix} [K_{11}]_{3 \times 3} & [K_{12}]_{3 \times 2} \\ [K_{21}]_{2 \times 3} & [K_{22}]_{2 \times 2} \end{bmatrix}$$

and

$$[\bar{C}]_{5 \times 5} = \begin{bmatrix} [C_{11}]_{3 \times 3} & [C_{12}]_{3 \times 2} \\ [C_{21}]_{2 \times 3} & [C_{22}]_{2 \times 2} \end{bmatrix}$$

where

$$[K_{11}]_{3 \times 3} = \begin{bmatrix} \sum \alpha K_{pi} & 0 & \sum \alpha K_{pi} y_i \\ 0 & \sum \alpha K_{pi} & \sum \alpha K_{pi} x_i \\ \sum \alpha K_{pi} y_i & \sum \alpha K_{pi} x_i & \sum \alpha K_{pi} (x_i^2 + y_i^2) \end{bmatrix}$$

$$[K_{12}]_{3 \times 2} = \begin{bmatrix} \sum (1-2\alpha) K_{pi} & 0 \\ 0 & \sum (1-2\alpha) K_{pi} \\ \sum (1-2\alpha) K_{pi} y_i & \sum (1-2\alpha) K_{pi} x_i \end{bmatrix}$$

$$[K_{21}]_{2 \times 3} = \begin{bmatrix} 0 & 0 & 0 \\ 0 & 0 & 0 \end{bmatrix}$$

$$[K_{22}]_{2 \times 2} = \begin{bmatrix} C_{1x} & 0 \\ 0 & C_{1y} \end{bmatrix}$$

$$[C_{11}]_{3 \times 3} = \begin{bmatrix} \sum C_{pi} & 0 & \sum C_{pi} y_i \\ 0 & \sum C_{pi} & \sum C_{pi} x_i \\ \sum C_{pi} y_i & \sum C_{pi} x_i & C_\theta \end{bmatrix}$$

$$[C_{12}]_{3 \times 2} = \begin{bmatrix} 0 & 0 \\ 0 & 0 \\ 0 & 0 \end{bmatrix}$$

$$[C_{21}]_{2 \times 3} = \begin{bmatrix} C_{1x} & 0 & C_{1x} e_{py} \\ 0 & C_{1y} & C_{1y} e_{px} \end{bmatrix}$$

$$[C_{22}]_{2 \times 2} = \begin{bmatrix} (1-C_{1x}) & 0 \\ 0 & (1-C_{1y}) \end{bmatrix}$$

$$\{F\}_{3 \times 1}^T = [[K_{11}] [K_{12}]]_{3 \times 5} \{U_{px} U_{py} U_\theta Z_{4x} Z_{4y}\}_{5 \times 1}^T$$

The matrices $[K_{1\alpha}]$ and $[H_{1\alpha}]$ of Eq. (76) are expressed as

$$[K_{1\alpha}] = [K_{11}]$$

$$[H_{1\alpha}] = [K_{12}]$$

Appendix III

The coefficients of Eqs. (14 and 15) are taken as Wen [17], Baber and Wen [3]

$$C_j = \sigma_{z_j}^2 \left(\frac{2\gamma}{\pi} \phi_j - \frac{\gamma}{\pi} \sin 2\phi_j \right) - A$$

$$C'_j = \sigma_{\dot{u}_j} \sigma_{z_j} \left(\frac{4\gamma}{\pi} (1 - \rho_{\dot{u}_j z_j}^2)^{1.5} \right) \times$$

$$\left\{ \rho_{\dot{u}_j z_j} \left(\frac{4\gamma}{\pi} \phi_j - \frac{2\gamma}{\pi} \sin 2\phi_j \right) + \frac{2\gamma}{\pi} (\cos \psi_j + \psi_j \rho_{\dot{u}_j z_j}) \right\}$$

$$\phi_j = \tan^{-1} \left[\frac{-\sqrt{1 - (\rho_{\dot{u}_j z_j})^2}}{\rho_{\dot{u}_j z_j}} \right]$$

$$\psi_j = \sin^{-1} \rho_{\dot{u}_j z_j}$$

$$\rho_{\dot{u}_j z_j} = \frac{E [\dot{U}_{jz_j}]}{\sigma_{\dot{u}_j} \sigma_{z_j}}$$

$j = x, y$